

JETON®

www.jeton.com.tw

Vacuum Flex Tube
Adjustable Coolant Hoses



JETON R/D & MFG. INC.
宏明工業股份有限公司 / 宏啓工業股份有限公司
No. 17, Lane 100, Tsao-Tyi Road, Ta-Li Dist., Taichung, Taiwan
台灣台中市大里區草堤路100巷17號
TEL: 886 - 4 - 24953456
FAX: 886 - 4 - 24953399
E-MAIL: jetoninc@seed.net.tw

上海奇晉貿易有限公司
上海市寶山區三泉路1859弄63號1202室
TEL: 021 - 65622765 . 021 - 65623571
FAX: 021 - 65159705
E-MAIL: jetoninc@163.com

JETON®
www.jeton.com.tw

It is our great pleasure introducing JETON R/D & MFG. INC.
This is a company has more than 20 year's extensive experiences in the field of Injection Industrial and we major manufacture and market JETON ADJUSTABLE COOLANT HOSE, HIGH PRESSURE ADJUSTABLE NOZZLE, VACUUM FLEX TUBE, DOLL ARMATURE.

JETON is one of the leading manufacturers in INJECTION INDUSTRIAL from 1983 especially in ADJUSTABLE COOLANT HOSE for machine tools.

In 1989, we use the reason of COOLANT HOSE to develop the product for Doll in ARMATURE that could be put into the stuff toys or ceramic doll, soft body and so on. It's made the toy to be looked life-like very much.

In 1994, we extend the range of toy's accessory with great varieties. In 1996, we use the modern techniques to combine and develop with flexible structuring parts for applications.

Nowadays we rename JETON R/D & MFG. INC. (Original: HONG CHYE INDUSTRIAL CO., LTD.) and hope you to support us in the future.

CONTENTS

Adjustable Coolant Hoses

Adjustable Coolant Hose Introduction.....03
 Length Calculation Method.....05
 Vacuum Flex Tube System.....07
 The Collocated Form of System and Accessories.....09
 System & Specification.....21-24



Adjustable Coolant Hoses

Adjustable Coolant Hose Introduction

Length and angle can be freely adjusted, suitable for most fluids (liquids and gases), hose orifice can be changed as needed. Can be used for air or for water/oil supply to metal processing machinery.

- ▶ Made using superior POM plastic steel; is strongly resistant to oils and chemicals.
- ▶ Adjustable Coolant Hose is highly pliable; it holds its shape well and will not spring back.
- ▶ Bending hose will not reduce inner diameter; hose will not pinch or fatigue.
- ▶ Adjustable Coolant Hose will not damage cutting blades if there is accidental contact.
- ▶ Adjustable Coolant Hose does not conduct electricity and is suitable for use on electrical discharge (EDM) machines.
- ▶ Five kinds of orifice inner diameter are available: 1/4", 3/8", 1/2", 3/4", 2 1/2".
- ▶ Adjustable Coolant Hose is designed for the transport of low-pressure fluids.



Hose Pressure and Flow Characteristics

System	Pressure (kg/cm ²)	Flow Rate (Liter / Hour)
1/4" SYSTEM	2.0~3.0	900
3/8" SYSTEM	2.0~3.0	1500
1/2" SYSTEM	1.4~2.0	1700
3/4" SYSTEM	0.7~1.4	1900

Recommended Usage

- ▶ When using Adjustable Coolant Hose, changes in the situation may affect the maximum pressure. It is recommended that tests be performed whenever changes are made.

Thermal Characteristics

- ▶ Melting point: 165° C
- ▶ Maximum use temperature: 65° C

Adjustable Coolant Hose Packaging

Adjustable Coolant Hose is available in cardboard boxes, bags, and coils to meet customers' specific needs.



LIST OF SUITABLE FLUIDS

Ordinary Adjustable Coolant Hoses are manufactured from acetal. Hose is available in dark blue and orange colors.

ITEM	SUITABLE	UNSUITABLE
ALCOHOLS, ETHYL	○	
ACETONE	○	
COMMERCIAL DISH DETERGENTS	○	
GASOLINE	○	
GREASES	○	
LACQUER SOLVENTS	○	
OILS	○	
SODIUM HYDROXIDE	○	
INSECTICIDES	○	
BRAKE OILS	○	
ACIDS		×
BASES, STRONG		×
AMMONIUM HYDROXIDE (STRONG)		×
HYPOCHLORITE ION SOLUTIONS		×
SODIUM HYPOCHLORITE		×

Omnipotent Adjustable Coolant Hose Packaging



Length Calculation Method

Adjustable Coolant Hoses Length Calculation Method Sample Calculations



Connector Size + Effective Hose Size + Nozzle = Total Length

(A) (B x Number of inter locking pieces) (C)

- ▶ **1/4"** 10.2 mm + 14.8 mm x Number of hoses + 35.2 mm = Total length
- ▶ **3/8"** 12.7 mm + 17.3 mm x Number of hoses + 39.2 mm = Total length
- ▶ **1/2"** 14.8 mm + 21.1 mm x Number of hoses + 37.8 mm = Total length
- ▶ **3/4"** 14.2 mm + 23.7 mm x Number of hoses + 43.0 mm = Total length

Installation of Adjustable Coolant Hoses

It's simple and easy to install Adjustable Coolant Hoses using the special pliers. The pliers can also be used to take apart the hose.

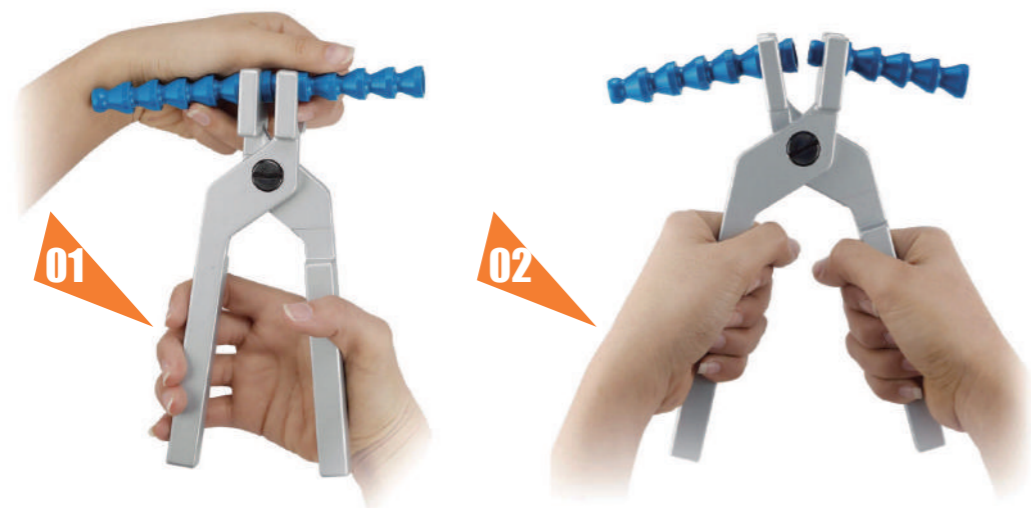

Total Flow Control Unit

The Total Flow Control Unit can be installed on all types of mechanical equipment to control of water flow. It is easy to install and makes machine more aesthetically attractive. Ensures convenient flow control.

JTM-01 CONTROL UNIT

- Total Flow Control Unit 1 set
- 1/4" Adjustable Coolant Hoses & Valves Unit 1 set
- 3/8" Adjustable Coolant Hoses & Valves Unit 3 set

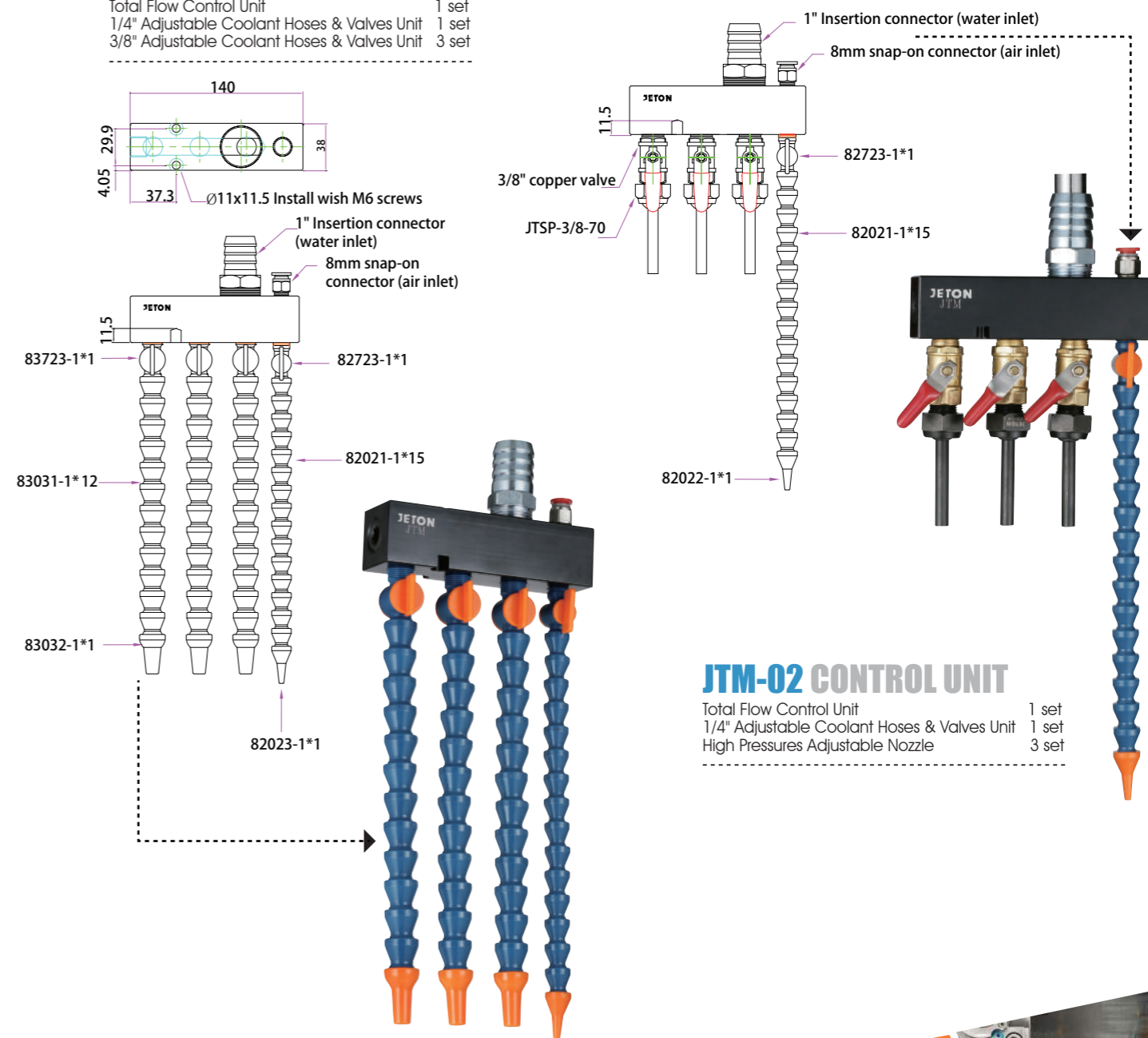

JTM-02 CONTROL UNIT

- Total Flow Control Unit 1 set
- 1/4" Adjustable Coolant Hoses & Valves Unit 1 set
- High Pressures Adjustable Nozzle 3 set

Total Flow Control Unit



Picture	Item	Description
	89091	Vacuum Segment Packs, 9 Elements 2.5" ID
	89191	Vacuum Segment Packs, 18 Elements 2.5" ID
	89291	Vacuum Segment Packs, 180 Elements 2.5" ID
	89094	4.5" Round Nozzle, pack of 1
	89194	4.5" Round Nozzle, pack of 10
	89092	6" x 3.5" Rectangular Nozzle, pack of 1
	89192	6" x 3.5" Rectangular Nozzle, pack of 10
	89093	Tapered Oval Nozzle, pack of 1
	89193	Tapered Oval Nozzle, pack of 10
	89722	2.5" Slide Valve, pack of 1
	89742	2.5" Slide Valve, pack of 10
	89096	Shop Vacuum Hose Adapter with Mounting Tab, pack of 1
	89196	Shop Vacuum Hose Adapter with Mounting Tab, pack of 10
	89095	Shop Vacuum Adapter, pack of 1
	89195	Shop Vacuum Adapter, pack of 10

Picture	Item	Description
	89098	3" PVC Adapter, (Connect to 3" PVC Pipe) pack of 1
	89198	3" PVC Adapter, (Connect to 3" PVC Pipe) pack of 10
	89097	3" Sheet Metal Duct Adapter, (Connect to 3" Metal Duct) pack of 1
	89197	3" Sheet Metal Duct Adapter, (Connect to 3" Metal Duct) pack of 10
	89099	Shop Vacuum Adapter, pack of 1
	89199	Shop Vacuum Adapter, pack of 10
	89021	4" to 2.5" Shop Vacuum Adapter, pack of 1
	89121	4" to 2.5" Shop Vacuum Adapter, pack of 10
	89038	4" to 2.5" Y Reducer, pack of 1
	89101	2.5" Fixed Base, pack of 1
	89102	4" to 2.5" Shop Vacuum Adapter Fixed Base, pack of 1
	89103	4" to 2.5" Y Reducer Fixed Base, pack of 1

Vacuum Flex Tube Features

This 2-1/2" vacuum flex tube is designed specifically for vacuum systems, and can be used for vacuuming dust, smoke, and particles. The tube's angle can be conveniently adjusted to reach every place within a work area. Length can also be adjusted to meet work needs. Several types of connectors and nozzles are also available, allowing users to select the most suitable setup. This 2 1/2" vacuum tube can be connected to a 3" PVC drainage pipe, 3" metal pipe, or a portable vacuum cleaner.

- ▶ The tube can be rotated 360°; angle is easily adjusted. Can be attached in an ideal working location.
- ▶ Durable, compression-resistant, wear-resistant.
- ▶ Made using superior DuPont plastic material; resistant to most chemicals.
- ▶ Highly flexible; bending will not reduce the inner diameter.
- ▶ Bending radius is approximately 145 mm.

TEMPERATURE SPECIFICATIONS

- ▶ Melting point: 165° C
- ▶ Maximum use temperature: 65° C





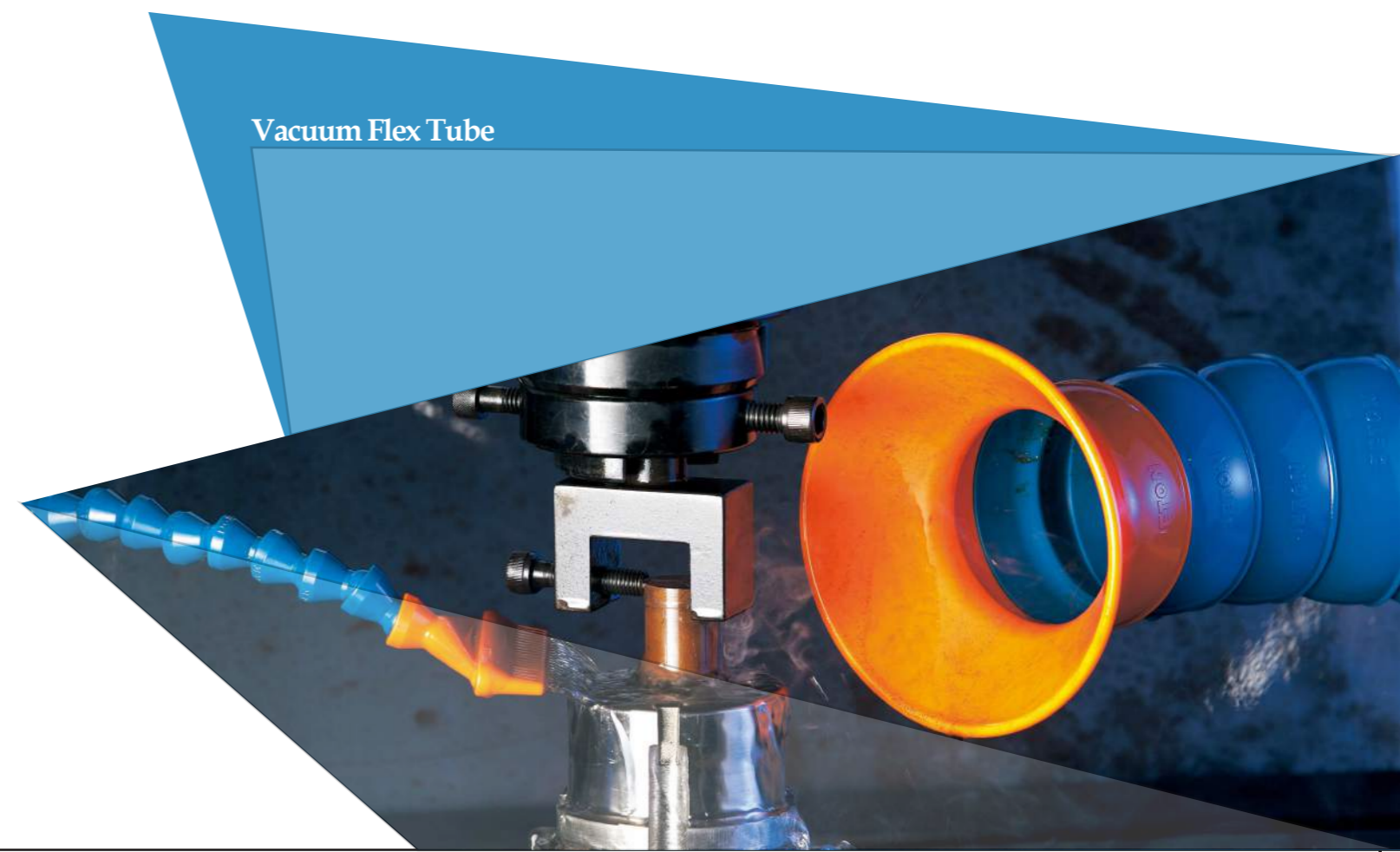

WARNING

- ▶ These vacuum flex tubes are made from plastic material. This material is highly flammable and must be kept away from sources of flame in order to prevent fire.



1/4" SYSTEM

▶ Male & Female Connector

- 82025**
1/8" PT Connector 
- 82026**
1/4" PT Connector 
- 82013**
5/8" Female UNF Connector 
- 82014**
7/16" Female UNF Connector 
- 82723**
1/4" Male PT Valve 
- 82724**
1/4" Female PT Valve 

▶ Polymorphic Connector

- 82028**
1/4" Y Fitting 
- 82011**
1/4" Double Socket 
- 82220**
1/4" Extended Element Kit with Element Clamp 
- 62420**
1/4" Elbow Fitting 
- 62422**
1/4" Side Flow Nozzle 
- 62424**
1/4" End Cap 
- 62426**
1/4" T Fitting 
- 82722**
1/4" Connection Valve 
- 82725**
1/4" In-Line Check Valve 

▶ Nozzle





- 82029**
1/4" PT Connector 
- 82012**
1/4" Socket to 1/8" NPT 
- 82052**
1/4" Female PT Connector 
- 82062**
1/4" Female NPTF Connector 
- 82054**
1/4" Flat Slot 40 Nozzle 
- 82055**
1/4" Flat Slot 60 Nozzle 
- 82056**
1/4" Flat 7 Hole Nozzle 
- 82057**
1/4" Flat 5 Hole Nozzle 
- 82053**
1" Straight Flow Nozzle 
- 82227**
2-1/2" Swivel Nozzle 75 
- 82022**
1/16" Round Nozzle 
- 82023**
1/8" Round Nozzle 
- 82024**
1/4" Round Nozzle 
- 82223**
1/16" 90° Nozzle 
- 82224**
1/8" 90° Nozzle 
- 82225**
1/4" 90° Nozzle 
- 82226**
1/4" 90° Spray Bar Nozzle 
- 82017**
3/8" Flat Nozzle 
- 82027**
1" Flare Nozzle 
- 82228**
1/4" Swivel Nozzle 40 
- 82229**
1/4" Swivel Nozzle 60 

3/8" SYSTEM

▶ Male & Female Connector

- 83035**
3/8" PT Connector 
- 83036**
1/2" PT Connector 
- 83026**
1/4" PT Connector 
- 83723**
3/8" Male PT Valve 
- 83724**
3/8" Female PT Valve 

▶ Polymorphic Connector





- 83038**
3/8" Y Fitting 
- 83011**
3/8" Double Socket 
- 83651**
3/8" to 1/4" Adapter 
- 83722**
3/8" Connection Valve 
- 83725**
3/8" In-Line Check Valve 

▶ Nozzle

- 83032**
1/4" Round Nozzle 
- 83033**
3/8" Round Nozzle 
- 83034**
1/2" Round Nozzle 
- 83037**
1-1/4" Flare Nozzle 

1/2" SYSTEM

▶ Male & Female Connector

- 84045**
1/2" PT Connector 
- 84046**
3/8" PT Connector 
- 84013**
3/8" SAE Flare Nut Adapter 
- 84723**
1/2" Male PT Valve 
- 84724**
1/2" Female PT Valve 

▶ Polymorphic Connector



- 84011**
1/2" Double Socket 
- 84048**
1/2" Y Fitting 
- 84049**
1/2" to 1/4" Y Reducer 
- 84651**
1/2" to 1/4" Adapter 
- 84440**
1/2" Extended Element Kit with Element Clamp 
- 64620**
1/2" Elbow Fitting 
- 64622**
1/2" Side Flow Nozzle 
- 64626**
1/2" T Fitting 
- 84722**
1/2" Connection Valve 
- 84725**
1/2" In-Line Check Valve 

▶ Nozzle





- 84047**
1-1/4" Flare Nozzle 
- 84050**
1-3/4" Flare Nozzle 
- 84052**
2-1/2" Flare Nozzle 
- 84054**
1/2" Flat Slot 40 Nozzle 
- 84055**
1/2" Flat Slot 60 Nozzle 
- 84056**
1/2" Flat 7 Hole Nozzle 
- 84057**
1/2" Flat 5 Hole Nozzle 
- 84058**
1-1/4" Straight Flow Nozzle 
- 84059**
1-5/8" Straight Flow Nozzle 
- 84042**
3/8" Round Nozzle 
- 84043**
1/2" Round Nozzle 
- 84044**
1/4" Round Nozzle 
- 84443**
1/4" 90° Nozzle 
- 84444**
3/8" 90° Nozzle 
- 84445**
1/2" 90° Nozzle 
- 84446**
1/2" 90° Spray Bar Nozzle 
- 84447**
2-1/2" Swivel Nozzle 75 for 1/2" 

3/4" SYSTEM



▶ Male & Female Connector

- 86064**
3/4" PT Connector 
- 86723**
3/4" Male PT Valve 
- 86724**
3/4" Female PT Valve 

▶ Polymorphic Connector

- 86068**
3/4" Y Fitting 
- 86069**
3/4" to 1/2" Y Reducer 
- 86051**
3/4" to 1/2" Adapter 
- 86011**
3/4" Double Socket 
- 66620**
3/4" Elbow Fitting 
- 86722**
3/4" Connection Valve 

▶ Nozzle

- 86063**
5/8" Round Nozzle 
- 86062**
3/4" Round Nozzle 
- 86067**
3" Flare Nozzle 

Picture	Item	Description	Picture	Item	Description	Picture	Item	Description	Picture	Item	Description	Picture	Item	Description
	82020	1/4" Hose Kit 10 pcs of 1/4" Segment - 2 sets 1/16", 1/8", 1/4" Nozzles 1/4" & 1/8" Male PT Connectors		82326	1/4" 90° Nozzle Kit 1 Each: 1/16" 90° Nozzle 1/8" 90° Nozzle 1/4" 90° Nozzle 1/4" 90° Spray Bar Nozzle		82054	1/4" Flat Slot 40 Nozzle, pack of 2		82028	1/4" Y Fitting, pack of 2		62422	1/4" Side Flow Nozzle, pack of 4
	82020A	1/4" Hose Kit 10 pcs of 1/4" Segment - 2 sets 1/16", 1/8", 1/4" Nozzles 1/4" & 1/8" Male NPT Connectors		82022	1/16" Round Nozzle, pack of 4		82055	1/4" Flat Slot 60 Nozzle, pack of 2		82038	1/4" Y Fitting, pack of 20		62442	1/4" Side Flow Nozzle, pack of 20
	82020A	1/4" Hose Kit 10 pcs of 1/4" Segment - 2 sets 1/16", 1/8", 1/4" Nozzles 1/4" & 1/8" Male NPT Connectors		82042	1/16" Round Nozzle, pack of 50		82075	1/4" Flat Slot 60 Nozzle, pack of 20		82011	1/4" Double Socket, pack of 4		62424	1/4" End Cap, pack of 4
	82220	1/4" Extended Element Kit Include 4 each of: 1/4" Extended Elements 1/4" Element Clamps		82023	1/8" Round Nozzle, pack of 4		82056	1/4" Flat Slot 7 Hole Nozzle, pack of 2		82012	1/4" Socket to 1/8" NPT, pack of 4		82227	2 1/2" Swivel Nozzle 75, pack of 2
	82220	1/4" Extended Element Kit Include 4 each of: 1/4" Extended Elements 1/4" Element Clamps		82043	1/8" Round Nozzle, pack of 50		82076	1/4" Flat Slot 7 Hole Nozzle, pack of 20		82032	1/4" Socket to 1/8" NPT, pack of 20		82247	2 1/2" Swivel Nozzle 75, pack of 20
	82021	1/4" Segment Pack 15 CM - 2 sets		82024	1/4" Round Nozzle, pack of 4		82057	1/4" Flat Slot 5 Hole Nozzle, pack of 2		82052	1/4" Female PT Connector, pack of 4		82228	1/4" Swivel Nozzle 40, pack of 2
	82051	1/4" Segment Pack 1524 CM Coil		82044	1/4" Round Nozzle, pack of 50		82077	1/4" Flat Slot 5 Hole Nozzle, pack of 20		82072	1/4" Female PT Connector, pack of 50		82248	1/4" Swivel Nozzle 40, pack of 20
	82071	2500 CM Coil		82223	1/16" 90° Nozzle, pack of 4		82053	1" Straight Flow Nozzle, pack of 2		82052F	1/4" Female PF Connector, pack of 4		82229	1/4" Swivel Nozzle 60, pack of 2
	62423	1/4" Circle Flow Nozzle Kit Assembled with 15 pcs of 1/4" Side Flow Nozzles & 1 pc of 1/4" End Cap		82243	1/16" 90° Nozzle, pack of 20		82073	1" Straight Flow Nozzle, pack of 20		82072F	1/4" Female PF Connector, pack of 50		82249	1/4" Swivel Nozzle 60, pack of 20
	82221	1/4" Extended Element, pack of 4		82224	1/8" 90° Nozzle, pack of 4		82025	1/8" PT Connector, pack of 4		82062	1/4" Female NPTF Connector, pack of 4		82721A	1/4" NPT Male Hose Nipple Valve, pack of 2
	82241	1/4" Extended Element, pack of 20		82244	1/8" 90° Nozzle, pack of 20		82035	1/8" PT Connector, pack of 50		82082	1/4" Female NPTF Connector, pack of 50		82731A	1/4" NPT Male Hose Nipple Valve, pack of 10
	82222	1/4" Element Clamp, pack of 4		82225	1/4" 90° Nozzle, pack of 4		82025A	1/8" NPT Connector, pack of 4		82013	5/8" Female UNF Connector, pack of 4		82722	1/4" Connection Valve, pack of 2
	82242	1/4" Element Clamp, pack of 20		82245	1/4" 90° Nozzle, pack of 20		82035A	1/8" NPT Connector, pack of 50		82033	5/8" Female UNF Connector, pack of 20		82732	1/4" Connection Valve, pack of 10
	82222	1/4" Element Clamp, pack of 4		82226	1/4" 90° Spray Bar Nozzle, pack of 2		82026	1/4" PT Connector, pack of 4		82014	7/16" Female UNF Connector, pack of 4		82723	1/4" Male PT Valve, pack of 2
	82242	1/4" Element Clamp, pack of 20		82246	1/4" 90° Spray Bar Nozzle, pack of 20		82036	1/4" PT Connector, pack of 50		82034	7/16" Female UNF Connector, pack of 20		82733	1/4" Male PT Valve, pack of 10
	82027	1" Flare Nozzle, pack of 2		82017	3/8" Flat Nozzle, pack of 2		82026A	1/4" NPT Connector, pack of 4		62420	1/4" Elbow Fitting, pack of 2		52400	1/4" Modular Manifold System 1/4" Elbow Fitting - 1 piece 1/4" Manifold Bracket - 1 piece 1/4" T Fitting - 3 pcs Mounting Screws - 3 pcs
	82047	1" Flare Nozzle, pack of 20		82037	3/8" Flat Nozzle, pack of 20		82036A	1/4" NPT Connector, pack of 50		62430	1/4" Elbow Fitting, pack of 20		52410	1/4" Main Flow Control Manifold System 1/4" Modular Manifold - 1 set 1/4" Connection Valve - 5 pcs
	82029	1/4" PT Connector, pack of 4		82027	1" Flare Nozzle, pack of 2		82029	1/4" PT Connector, pack of 4		62426	1/4" T Fitting, pack of 2		52416	1/4" Manifold Bracket, pack of 2
	82039	1/4" PT Connector, pack of 50		82047	1" Flare Nozzle, pack of 20		82039	1/4" PT Connector, pack of 50		62436	1/4" T Fitting, pack of 20		26171	1/4" Hose Assembly Pliers

Picture	Item	Description	Picture	Item	Description	Picture	Item	Description
	83030	3/8" Hose Kit 8 pcs of 3/8" Segment - 2 sets 3/8" Nozzle 3/8" Male PT Connector		83032	1/4" Round Nozzle, pack of 4		83038	3/8" Y Fitting, pack of 2
	83030A	3/8" Hose Kit 8 pcs of 3/8" Segment - 2 sets 3/8" Nozzle 3/8" Male NPT Connector		83052	1/4" Round Nozzle, pack of 50		83058	3/8" Y Fitting, pack of 20
	83033	3/8" Round Nozzle, pack of 4		83034	1/2" Round Nozzle, pack of 4		83011	3/8" Double Socket, pack of 4
	83034	1/2" Round Nozzle, pack of 4		83053	3/8" Round Nozzle, pack of 50		83041	3/8" Double Socket, pack of 20
	83035	3/8" PT Connector, pack of 4		83054	1/2" Round Nozzle, pack of 50		83725	3/8" In-Line Check Valve, pack of 2
	83036	1/2" PT Connector, pack of 4		83055	3/8" PT Connector, pack of 50		83745	3/8" In-Line Check Valve, pack of 10
	83037	1 1/4" Flare Nozzle, pack of 2		83026	1/4" PT Connector, pack of 4		83651	3/8" to 1/4" Adapter, pack of 2
	83051	3/8" Segment Pack 762 CM Coil		83046	1/4" PT Connector, pack of 50		83851	3/8" to 1/4" Adapter, pack of 20
	83091	3/8" Segment Pack 1524 CM Coil		83035A	3/8" NPT Connector, pack of 4		83722	3/8" Connection Valve, pack of 2
				83055A	3/8" NPT Connector, pack of 50		83742	3/8" Connection Valve, pack of 10
				83036A	1/2" NPT Connector, pack of 4		83723	3/8" Male PT Valve, pack of 2
				83056A	1/2" NPT Connector, pack of 50		83743	3/8" Male PT Valve, pack of 10
				83037A	3/8" Male NPT Valve, pack of 2		83723A	3/8" Male NPT Valve, pack of 2
				83057	1 1/4" Flare Nozzle, pack of 20		83743A	3/8" Male NPT Valve, pack of 10
							83724	3/8" Female PT Valve, pack of 2
							83744	3/8" Female PT Valve, pack of 10
							83724A	3/8" Female NPT Valve, pack of 2
							83744A	3/8" Female NPT Valve, pack of 10
				26176	3/8" Hose Assembly Pliers			

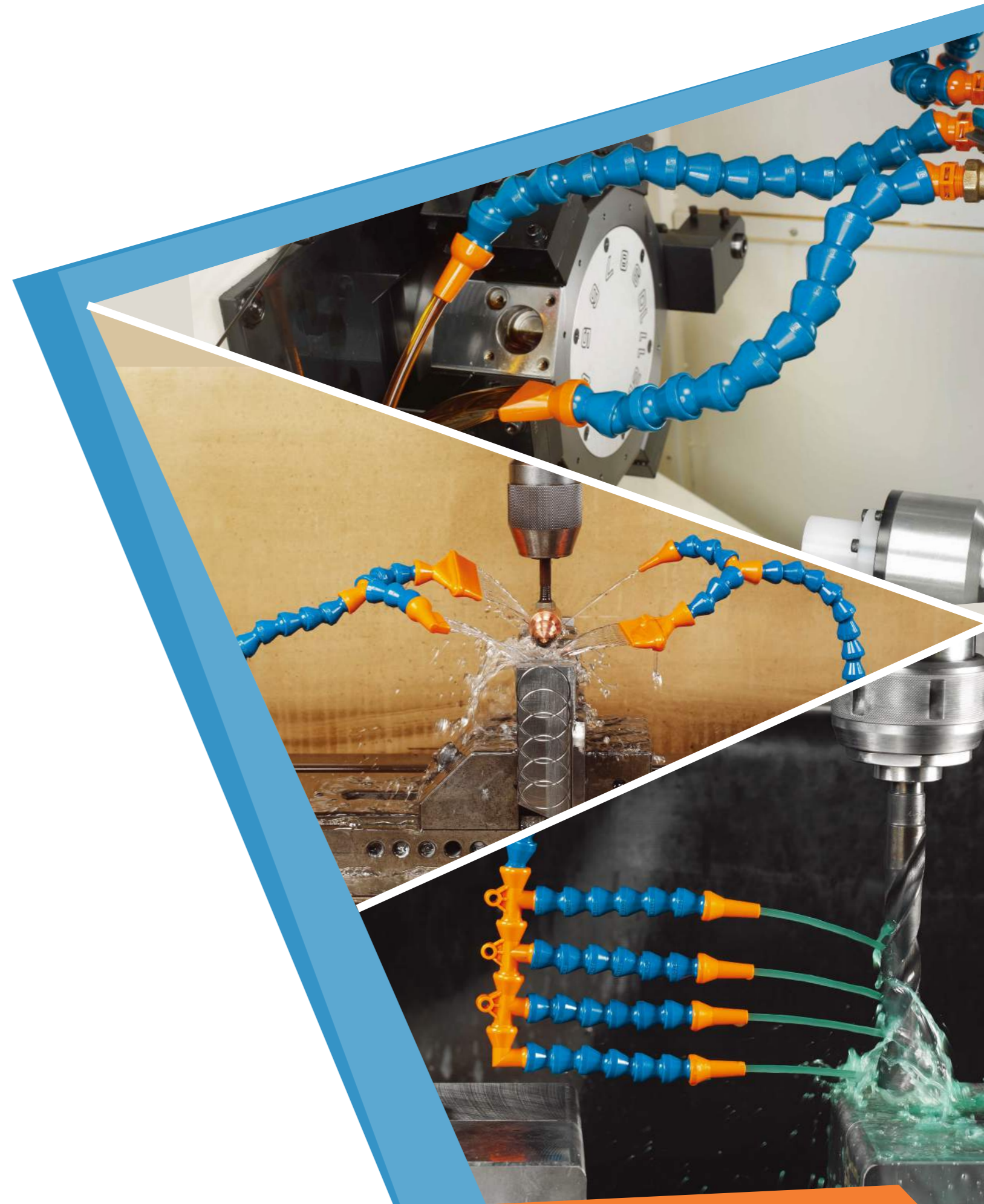

Picture	Item	Description	Picture	Item	Description	Picture	Item	Description	Picture	Item	Description	Picture	Item	Description			
	84040	1/2" Hose Kit 6 pcs of 1/2" Segment - 2 sets 1/4", 3/8", 1/2" Nozzles 3/8", 1/2" Male PT Connectors		84346	90° Nozzle Kit 1 Each: 1/4" 90° Nozzle 3/8" 90° Nozzle 1/2" 90° Nozzle 1/2" 90° Spray Bar Nozzle		84054	1/2" Flat Slot 40 Nozzle, pack of 2		84447	2 1/2" Swivel Nozzle 75 for 1/2", pack of 2		64620	1/2" Elbow Fitting, pack of 2		84725	1/2" In-Line Check Valve, pack of 2
	84040A	1/2" Hose Kit 6 pcs of 1/2" Segment - 2 sets 1/4", 3/8", 1/2" Nozzles 3/8", 1/2" Male NPT Connectors		84044	1/4" Round Nozzle, pack of 4		84055	1/2" Flat Slot 60 Nozzle, pack of 2		84467	2 1/2" Swivel Nozzle 75 for 1/2", pack of 20		64640	1/2" Elbow Fitting, pack of 20		84745	1/2" In-Line Check Valve, pack of 10
	84440	1/2" Extended Element Kit Includes 4 each of: 1/2" Extended Elements 1/2" Element Clamps		84064	1/4" Round Nozzle, pack of 50		84075	1/2" Flat Slot 60 Nozzle, pack of 20		84046	3/8" PT Connector, pack of 4		64626	1/2" T Fitting, pack of 2		84013	3/8" SAE Flare Nut Adapter(5/8"-18 Thread), pack of 4
	84041	1/2" Segment Pack 13.5 CM - 2 sets		84042	3/8" Round Nozzle, pack of 4		84076	1/2" Flat Slot 7 Hole Nozzle, pack of 20		84066	3/8" PT Connector, pack of 50		64646	1/2" T Fitting, pack of 20		84033	3/8" SAE Flare Nut Adapter(5/8"-18 Thread), pack of 20
	84081 84091	1/2" Segment Pack 1524 CM Coil 2500 CM Coil		84043	1/2" Round Nozzle, pack of 4		84056	1/2" Flat Slot 7 Hole Nozzle, pack of 2		84046A	3/8" NPT Connector, pack of 4		64622	1/2" Side Flow Nozzle, pack of 4		54400	1/2" Modular Manifold System 1/2" Elbow Fitting - 1 piece 1/2" Manifold Bracket - 1 piece 1/2" T Fitting - 3 pcs Mounting Screws - 3 pcs
	64643	1/2" Circle Flow Nozzle Kit Assemble with 15 pcs of 1/2" Side Flow Nozzles & 1 pc of 1/2" End Cap		84062	3/8" Round Nozzle, pack of 50		84057	1/2" Flat Slot 5 Hole Nozzle, pack of 2		84077	1/2" Flat Slot 5 Hole Nozzle, pack of 20		64624	1/2" End Cap, pack of 4		54410	1/2" Main Flow Control Manifold System 1/2" Modular Manifold - 1 set 1/2" Connection Valve - 5 pcs
	84441 84461	1/2" Extended Element, pack of 4 1/2" Extended Element, pack of 20		84063	1/2" Round Nozzle, pack of 50		84058	1 1/4" Straight Flow Nozzle, pack of 2		84058	1 1/4" Straight Flow Nozzle, pack of 2		64644	1/2" End Cap, pack of 20		54416	1/2" Manifold Bracket, pack of 2
	64643	1/2" Circle Flow Nozzle Kit Assemble with 15 pcs of 1/2" Side Flow Nozzles & 1 pc of 1/2" End Cap		84443	1/4" 90° Nozzle, pack of 4		84078	1 1/4" Straight Flow Nozzle, pack of 20		84059	1 5/8" Straight Flow Nozzle, pack of 2		84048	1/2" Y Fitting, pack of 2		84723	1/2" Male PT Valve, pack of 2
	84442 84462	1/2" Extended Element, pack of 4 1/2" Extended Element, pack of 20		84463	1/4" 90 Nozzle, pack of 20		84079	1 5/8" Straight Flow Nozzle, pack of 20		84068	1/2" Y Fitting, pack of 20		84068	1/2" Y Fitting, pack of 20		84743	1/2" Male PT Valve, pack of 10
	84442 84462	1/2" Extended Clamp, pack of 4 1/2" Extended Clamp, pack of 20		84444	3/8" 90° Nozzle, pack of 4		84047	1 1/4" Flare Nozzle, pack of 2		84049	1/2" to 1/4" Y Reducer, pack of 2		84723A	1/2" Male NPT Valve, pack of 2		26172	1/2" Hose Assembly Pliers
	84442 84462	1/2" Extended Clamp, pack of 4 1/2" Extended Clamp, pack of 20		84464	3/8" 90° Nozzle, pack of 20		84067	1 1/4" Flare Nozzle, pack of 20		84069	1/2" to 1/4" Y Reducer, pack of 20		84743A	1/2" Male NPT Valve, pack of 10			
	84441 84461	1/2" Extended Element, pack of 4 1/2" Extended Element, pack of 20		84445	1/2" 90° Nozzle, pack of 4		84050	1 3/4" Flare Nozzle, pack of 2		84651	1/2" to 1/4" Adapter, pack of 2		84724	1/2" Female PT Valve, pack of 2			
	84441 84461	1/2" Extended Element, pack of 4 1/2" Extended Element, pack of 20		84465	1/2" 90° Nozzle, pack of 20		84070	1 3/4" Flare Nozzle, pack of 20		84851	1/2" to 1/4" Adapter, pack of 20		84744	1/2" Female PT Valve, pack of 10			
	84442 84462	1/2" Extended Clamp, pack of 4 1/2" Extended Clamp, pack of 20		84446	1/2" 90° Spray Bar Nozzle, pack of 2		84052	2 1/2" Flare Nozzle, pack of 2		84011	1/2" Double Socket, pack of 4		84724A	1/2" Female NPT Valve, pack of 2			
	84442 84462	1/2" Extended Clamp, pack of 4 1/2" Extended Clamp, pack of 20		84466	1/2" 90° Spray Bar Nozzle, pack of 20		84072	2 1/2" Flare Nozzle, pack of 20		84031	1/2" Double Socket, pack of 20		84744A	1/2" Female NPT Valve, pack of 10			

3/4" SYSTEM (3/4" Inside Diameter)

Picture	Item	Description	Picture	Item	Description	Picture	Item	Description
	86060	3/4" Hose Kit 6 pcs of 3/4" Segment - 2 sets 5/8" & 3/4" Nozzles 3/4" Male PT Connector		86064A	3/4" NPT Connector, pack of 4		86011	3/4" Double Socket, pack of 4
	86074A	3/4" NPT Connector, pack of 50		86031	3/4" Double Socket, pack of 20		66620	3/4" Elbow Fitting, pack of 2
	86060A	3/4" Hose Kit 6 pcs of 3/4" Segment - 2 sets 5/8" & 3/4" Nozzles 3/4" Male NPT Connector		86021	3/4" Fixed Mount, pack of 2		66640	3/4" Elbow Fitting, pack of 20
	86022	3/4" Magnetic Base, pack of 1		86722	3/4" Connection Valve, pack of 2		86742	3/4" Connection Valve, pack of 10
	86061	3/4" Segment Pack 15 CM - 2 sets		86023	Shield Mounting Elbow, pack of 2		86723	3/4" Male PT Valve, pack of 2
	86081	3/4" Segment Pack 1524 CM Coil		86743	3/4" Male PT Valve, pack of 10		86723A	3/4" Male NPT Valve, pack of 2
	86091	3/4" Segment Pack 2500 CM Coil		86067	3" Flare Nozzle, pack of 2		86743A	3/4" Male NPT Valve, pack of 10
	86063	5/8" Round Nozzle, pack of 4		86077	3" Flare Nozzle, pack of 20		86724	3/4" Female PT Valve, pack of 2
	86073	5/8" Round Nozzle, pack of 50		86068	3/4" Y Fitting, pack of 2		86744	3/4" Female PT Valve, pack of 10
	86062	3/4" Round Nozzle, pack of 4		86078	3/4" Y Fitting, pack of 20		86724A	3/4" Female NPT Valve, pack of 2
	86072	3/4" Round Nozzle, pack of 50		86069	3/4" to 1/2" Y Reducer, pack of 2		86744A	3/4" Female NPT Valve, pack of 10
	86064	3/4" PT Connector, pack of 4		86079	3/4" to 1/2" Y Reducer, pack of 20		26177	3/4" Hose Assembly Pliers
	86074	3/4" PT Connector, pack of 50		86051	3/4" to 1/2" Adapter, pack of 2			
				86071	3/4" to 1/2" Adapter, pack of 20			

Adjustable Coolant Hoses & Valves

	62720 36cm Length Hose Kit	1/4"	62721 36cm Length Hose Kit
	1/4" Male PT or NPT Valve 1 piece		1/4" Female PT or NPT Valve 1 piece
	20 pcs of 1/4" Segment 1 piece		20 pcs of 1/4" Segment 1 piece
	1/16", 1/8" or 1/4" Round Nozzle 1 piece		1/16", 1/8" or 1/4" Round Nozzle 1 piece
	63720 36cm Length Hose Kit	3/8"	63721 36cm Length Hose Kit
	3/8" Male PT or NPT Valve 1 piece		3/8" Female PT or NPT Valve 1 piece
	16 pcs of 3/8" Segment 1 piece		16 pcs of 3/8" Segment 1 piece
	1/4", 3/8" or 1/2" Round Nozzle 1 piece		1/4", 3/8" or 1/2" Round Nozzle 1 piece
	64720 35cm Length Hose Kit	1/2"	64721 35cm Length Hose Kit
	1/2" Male PT or NPT Valve 1 piece		1/2" Female PT or NPT Valve 1 piece
	12 pcs of 1/2" Segment 1 piece		12 pcs of 1/2" Segment 1 piece
	1/4", 3/8" or 1/2" Round Nozzle 1 piece		1/4", 3/8" or 1/2" Round Nozzle 1 piece
	66720 40cm Length Hose Kit	3/4"	66721 40cm Length Hose Kit
	3/4" Male PT or NPT Valve 1 piece		3/4" Female PT or NPT Valve 1 piece
	12 pcs of 3/4" Segment 1 piece		12 pcs of 3/4" Segment 1 piece
	5/8" or 3/4" Round Nozzle 1 piece		5/8" or 3/4" Round Nozzle 1 piece

1/4"

Item	Description
1/4" Acid Resistant Segment Pack	
52021	14 cm 2 pcs
52051	1524 cm 1 coil
52071	2500 cm 1 coil
1/16" Acid Resistant Round Nozzle	
52022	pack of 4
52042	pack of 50
1/8" Acid Resistant Round Nozzle	
52023	pack of 4
52043	pack of 50
1/4" Acid Resistant Round Nozzle	
52024	pack of 4
52044	pack of 50
3/8" Acid Resistant Flare Nozzle	
52017	pack of 2
52037	pack of 20
1" Acid Resistant Flare Nozzle	
52027	pack of 2
52047	pack of 20
1/8" Acid Resistant PT Connector	
52025	pack of 4
52035	pack of 50
1/8" Acid Resistant NPT Connector	
52025A	pack of 4
52035A	pack of 50
1/4" Acid Resistant PT Connector	
52026	pack of 4
52036	pack of 50
1/4" Acid Resistant NPT Connector	
52026A	pack of 4
52036A	pack of 50
1/4" Acid Resistant PT Connector	
52029	pack of 4
52039	pack of 50
1/4" Acid Resistant Y Fitting	
52028	pack of 4
52038	pack of 50
1/4" Acid Resistant Double Socket	
52011	pack of 4
52031	pack of 20
1/4" Acid Resistant Elbow Fitting	
52420	pack of 2
52430	pack of 20
1/4" Acid Resistant T Fitting	
52426	pack of 2
52436	pack of 20

3/8"

Item	Description
3/8" Acid Resistant Segment Pack	
53031	14.5 cm 2 pcs
53051	762 cm 1 coil
53091	1524 cm 1 coil
1/4" Acid Resistant Round Nozzle	
53032	pack of 4
53052	pack of 50
3/8" Acid Resistant Round Nozzle	
53033	pack of 4
53053	pack of 50
1/2" Acid Resistant Round Nozzle	
53034	pack of 4
53054	pack of 50
1/4" Acid Resistant PT Connector	
53026	pack of 4
53046	pack of 50
3/8" Acid Resistant PT Connector	
53035	pack of 4
53055	pack of 50
3/8" Acid Resistant NPT Connector	
53035A	pack of 4
53055A	pack of 50
1/2" Acid Resistant PT Connector	
53036	pack of 4
53056	pack of 50
1/2" Acid Resistant NPT Connector	
53036A	pack of 4
53056A	pack of 50
1-1/4" Acid Resistant Flare Nozzle	
53037	pack of 2
53057	pack of 20

1/2"

Item	Description
1/2" Acid Resistant Segment Pack	
54041	14 cm 2 pcs
54081	1524 cm 1 coil
53091	2500 cm 1 coil
1/4" Acid Resistant Round Nozzle	
54044	pack of 4
54064	pack of 50
3/8" Acid Resistant Round Nozzle	
54042	pack of 4
54062	pack of 50
1/2" Acid Resistant Round Nozzle	
54043	pack of 4
54063	pack of 50
1-1/4" Acid Resistant Flare Nozzle	
54047	pack of 2
54067	pack of 20
1-3/4" Acid Resistant Flare Nozzle	
54050	pack of 2
54070	pack of 20
2-1/2" Acid Resistant Flare Nozzle	
54052	pack of 2
54072	pack of 20
3/8" Acid Resistant PT Connector	
54046	pack of 4
54066	pack of 50
3/8" Acid Resistant NPT Connector	
54046A	pack of 4
54066A	pack of 50
1/2" Acid Resistant PT Connector	
54045	pack of 4
54065	pack of 50
1/2" Acid Resistant NPT Connector	
54045A	pack of 4
54065A	pack of 50
1/2" Acid Resistant Y Fitting	
54048	pack of 2
54068	pack of 20
1/2" to 1/4" Acid Resistant Y Fitting	
54049	pack of 2
54069	pack of 20
1/2" to 1/4" Acid Resistant Adapter	
54651	pack of 2
54851	pack of 20
1/2" Acid Resistant Double Socket	
54011	pack of 4
54031	pack of 20
1/2" Acid Resistant Elbow Fitting	
54620	pack of 2
54640	pack of 20
1/2" Acid Resistant T Fitting	
54626	pack of 2
54646	pack of 20

LISTE OF SUITABLE FLUIDS

Acid Resistant Adjustable Coolant Hoses
Hose is Available in Gray Color

ITEM	SUITABLE	UNSUITABLE
ALCOHOLS, ETHYL	○	
ACIDS, (LESS THAN 65° C)	○	
GASOLINE	○	
GREASES	○	
HYDROCARBONS	○	
OILS	○	
SALT SOLUTIONS	○	
WATER (GREATER THAN 65° C)		X
ACIDS, (GREATER THAN 65° C)		X
ACETONE		X
AROMATIC SOLVENTS		X
CHLORINATED HYDROCARBON		X
ETHYL ACETATE		X
BASES, STRONG		X



Shield Board System



Shield Kit

- 34101** (6" x 8")
- 34102** (7-1/2" x 10")
- 34103** (8-1/2" x 12")

Magnetic Base	1 set
12 pcs of 3/4" Segment	1 piece
3/4" Shield Mounting Elbows	1 piece
3/4" Fixed Mount	1 piece
Nut	2 pcs
Acrylic Board	1 piece

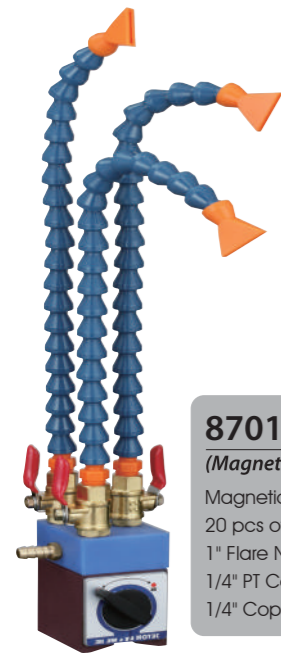

87011 Magnetic Set
(Magnetic Force On-Off)

Magnetic Base (W5xL6.5xH5 CM)	1 set
20 pcs of 1/4" Segment	3 pcs
1" Flare Nozzle	3 pcs
1/4" PT Connector	3 pcs
1/4" Copper Valve	3 pcs



87002 Magnetic Set
(Magnetic Force On-Off)

Magnetic Base (W5xL6.5xH5 CM)	1 set
20 pcs of 1/4" Segment	2 pcs
1" Flare Nozzle	2 pcs
1/4" PT Connector	2 pcs
1/4" Copper Valve	2 pcs

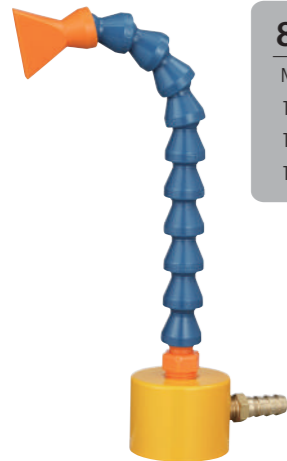

88003 Magnetic Set

Magnetic Base	1 set
10 pcs of 1/4" Segment	1 piece
1" Flare Nozzle	1 piece
1/4" PT Connector	1 piece

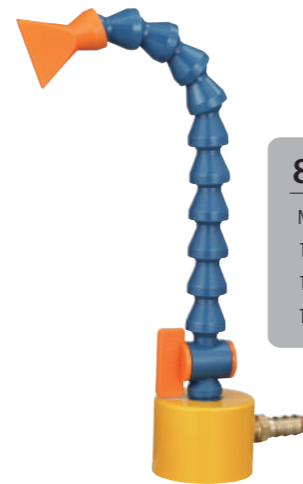

88005 Magnetic Set

Magnetic Base	1 set
10 pcs of 1/4" Segment	1 piece
1" Flare Nozzle	1 piece
1/4" Male PT Valve	1 piece

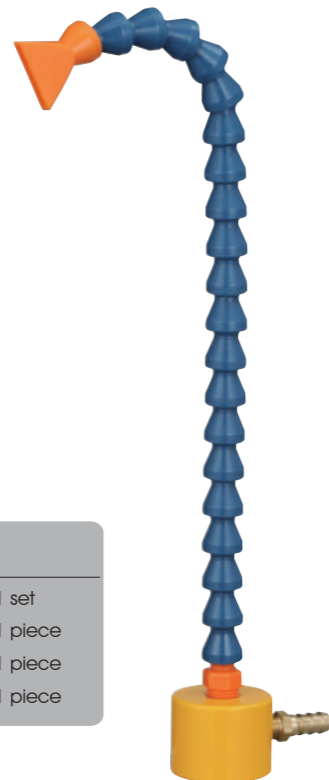

88103 Magnetic Set

Magnetic Base	1 set
20 pcs of 1/4" Segment	1 piece
1" Flare Nozzle	1 piece
1/4" PT Connector	1 piece

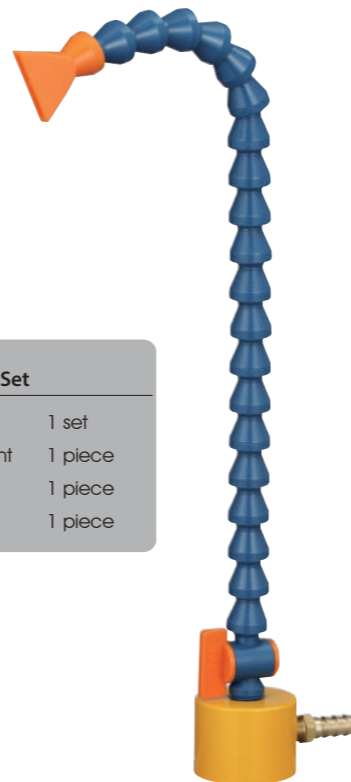

88105 Magnetic Set

Magnetic Base	1 set
20 pcs of 1/4" Segment	1 piece
1" Flare Nozzle	1 piece
1/4" Male PT Valve	1 piece

1/4" SYSTEM & SPECIFICATION

82021+82021	82022	82023	82024	82025	82026
82027	82028	82029	82030	82031	82032
82033	82034	82035	82036	82037	82038
82039	82040	82041	82042	82043	82044
82045	82046	82047	82048	82049	82050
82051	82052	82053	82054	82055	82056
82057	82058	82059	82060	82061	82062

3/8" SYSTEM & SPECIFICATION

1/2" SYSTEM & SPECIFICATION

1/2" SYSTEM & SPECIFICATION

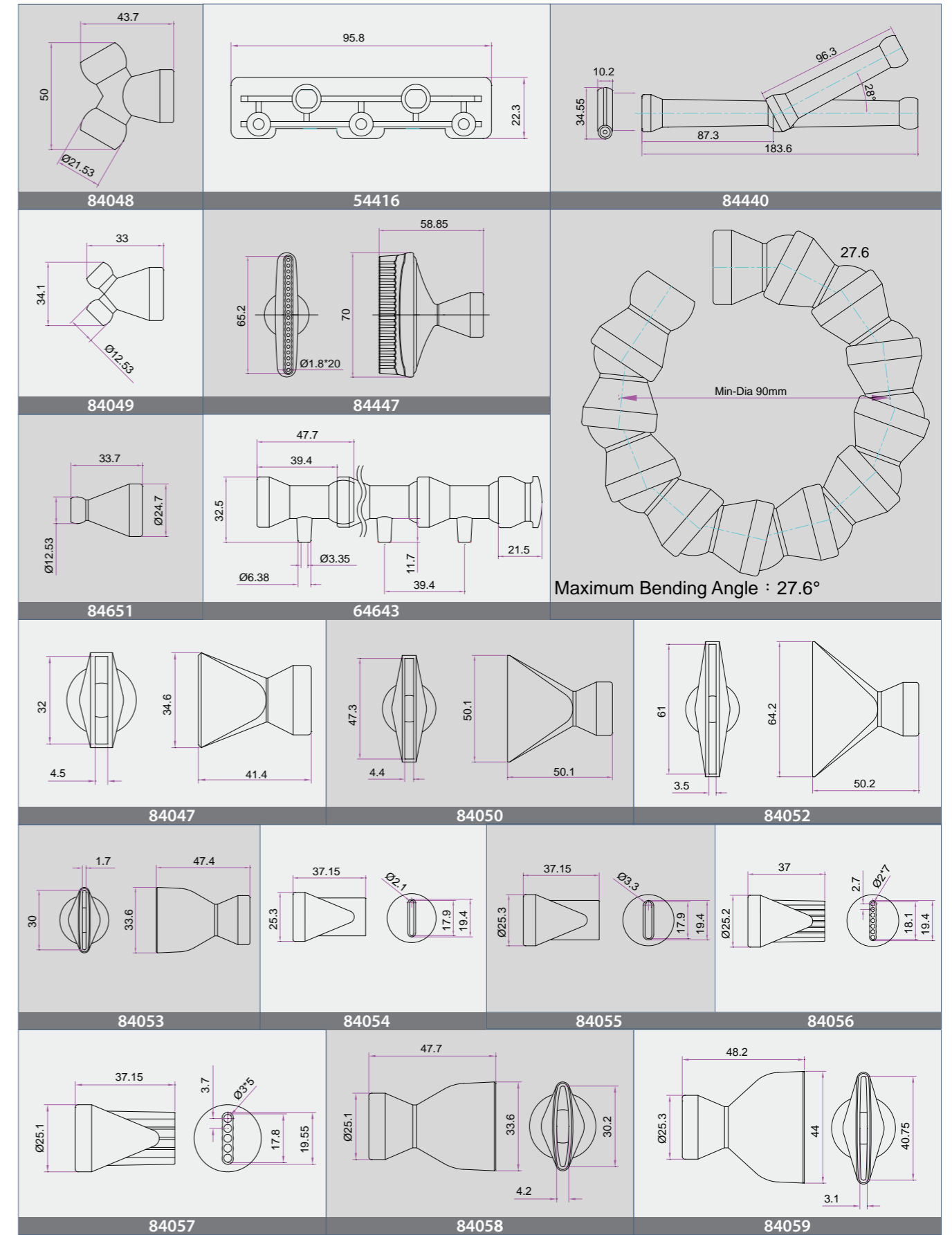
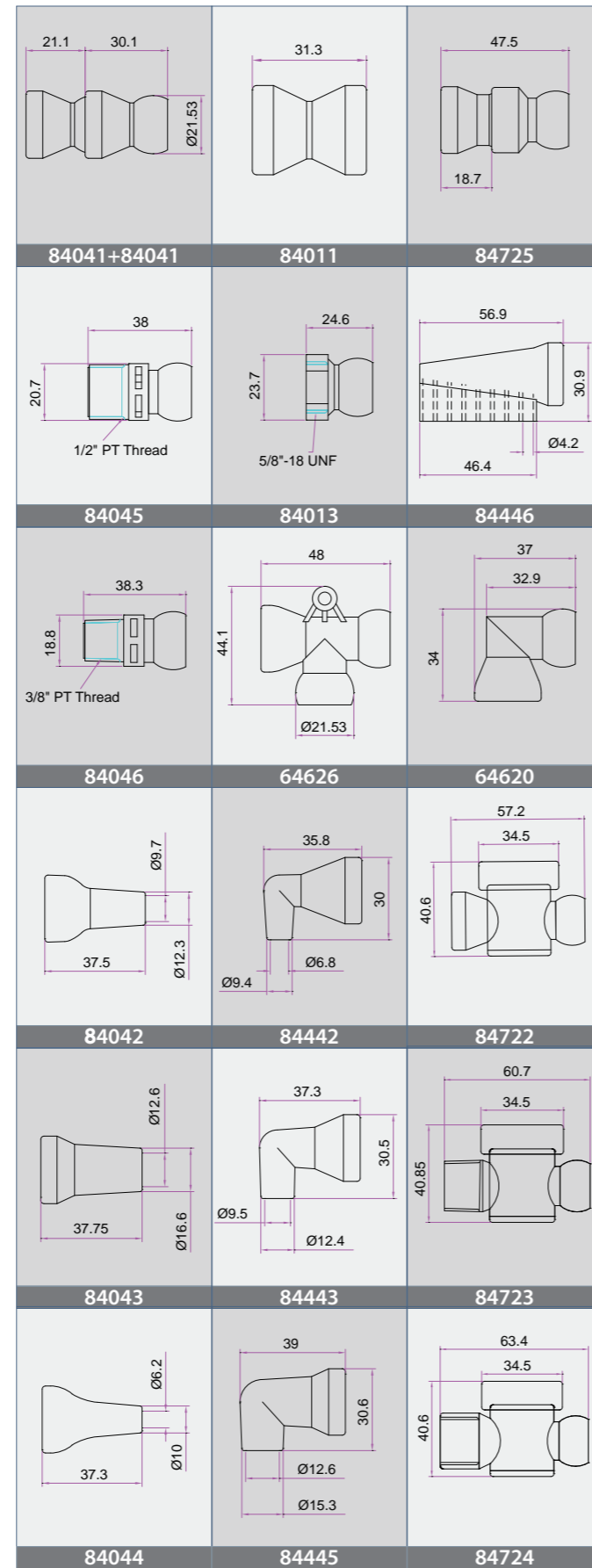
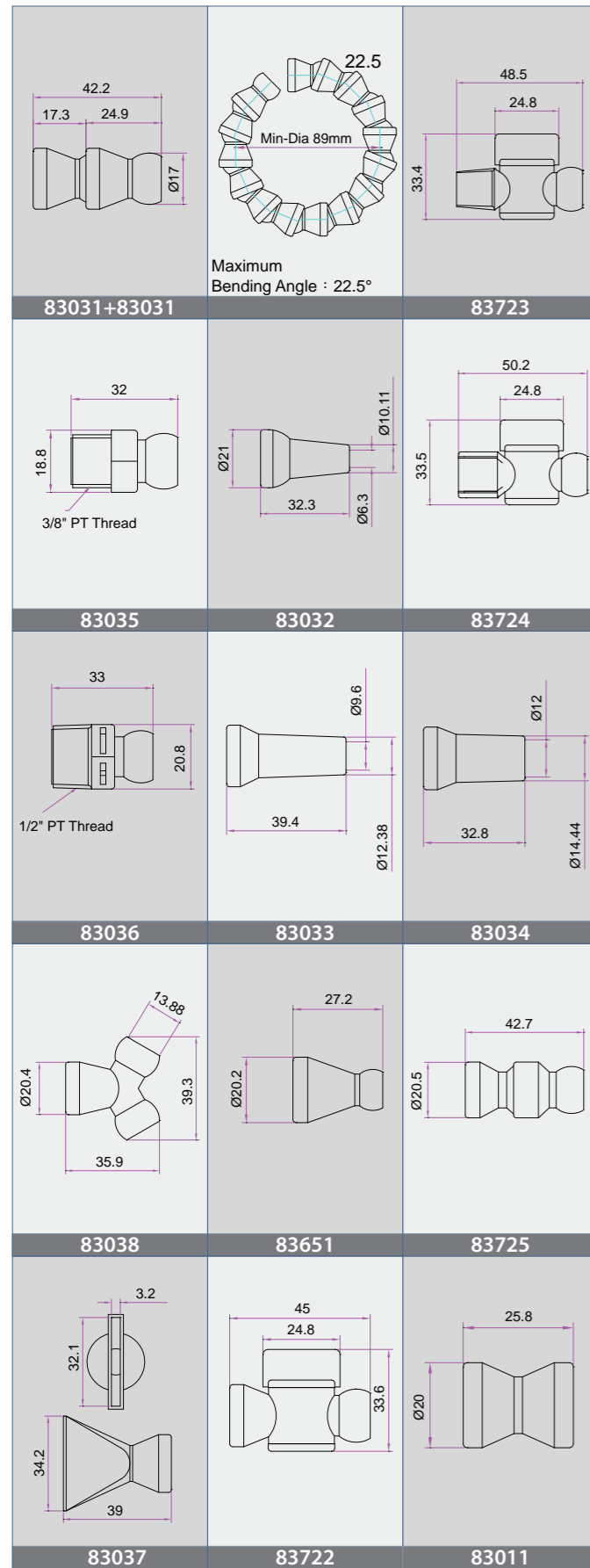

3/4" SYSTEM & SPECIFICATION

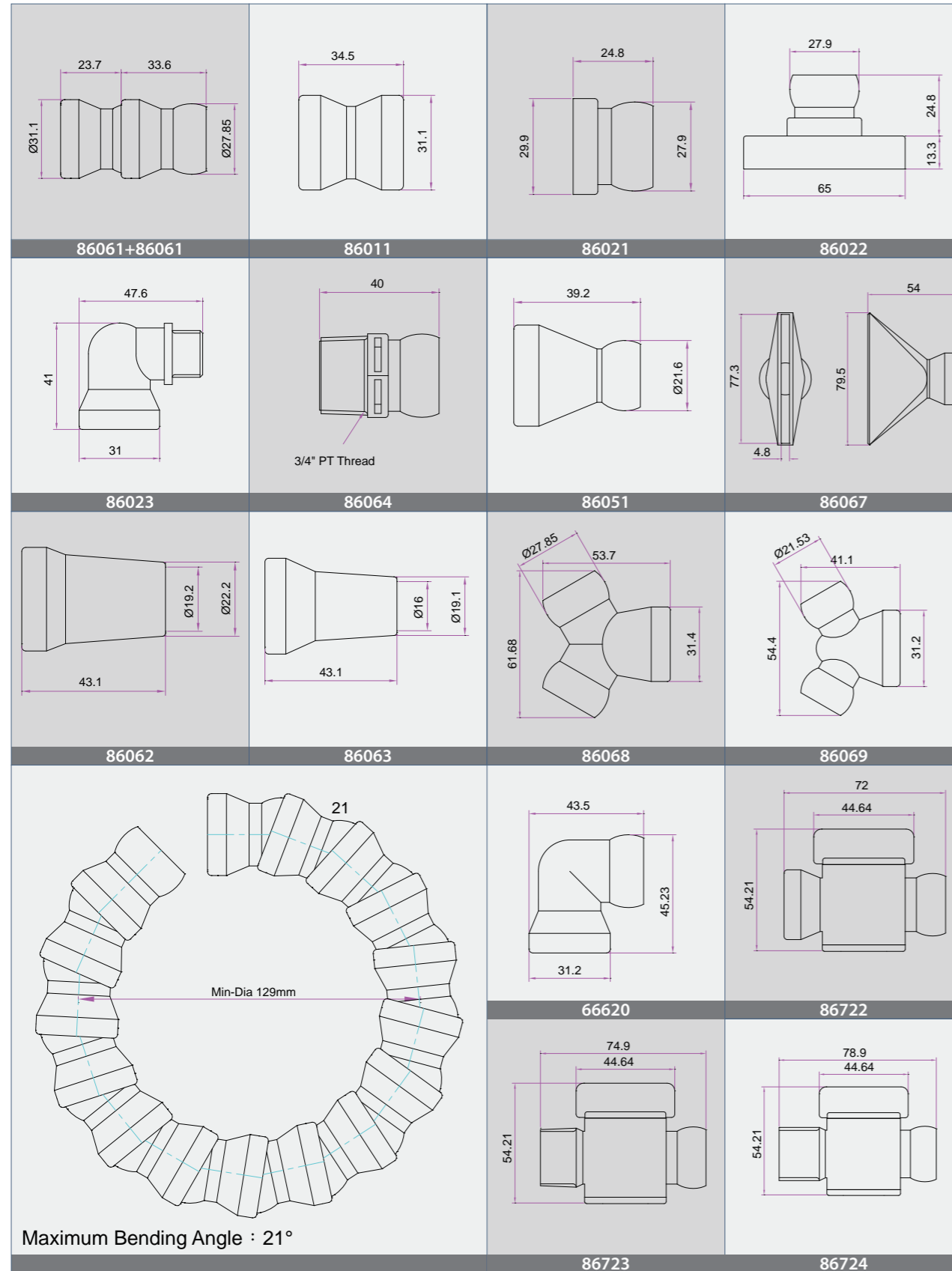

2 1/2" SYSTEM & SPECIFICATION

